

YAGI-4E

i. Electrical Specification

Frequency Range	VHF / UHF	
Polarization	Vertical	
Band Width	5 / 20 Mhz	
Gain	≥ 8dBi	
Beam width	Horizontal	≥ 70°
	Vertical	≥ 50°
F-B ratio (Horizontal & Vertical)	-	
VSWR	1 : 1.5	
Impedance	50 Ω	
Maximum input power	250 W	

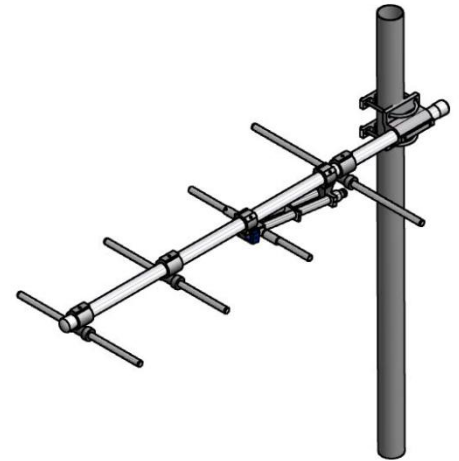

ii. Mechanical Specification

Radom Dimension (H x W x D)	800 x 425 x 70mm	
Weight (Include bracket)	≤ 10 Kg	
Connector Type	N-Female	
Withstand Wind Pressure	60 m/sec	
Radome Material	AL	
Radome Color	-	
Mechanical Down Tilt	-	
	-	
Temperature	-40 °C ~ 70 °C	

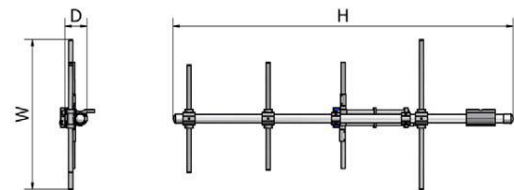

iii. Radiation Pattern

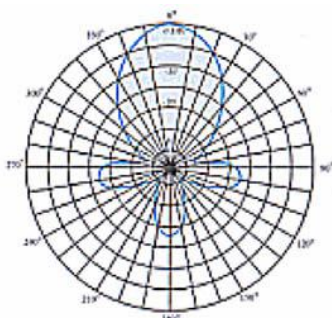

Horizontal Pattern

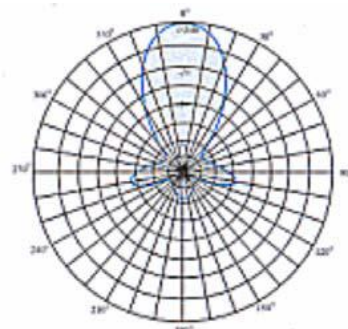

Vertical Pattern